

HUFFMAN WELDING & MACHINE, INC.

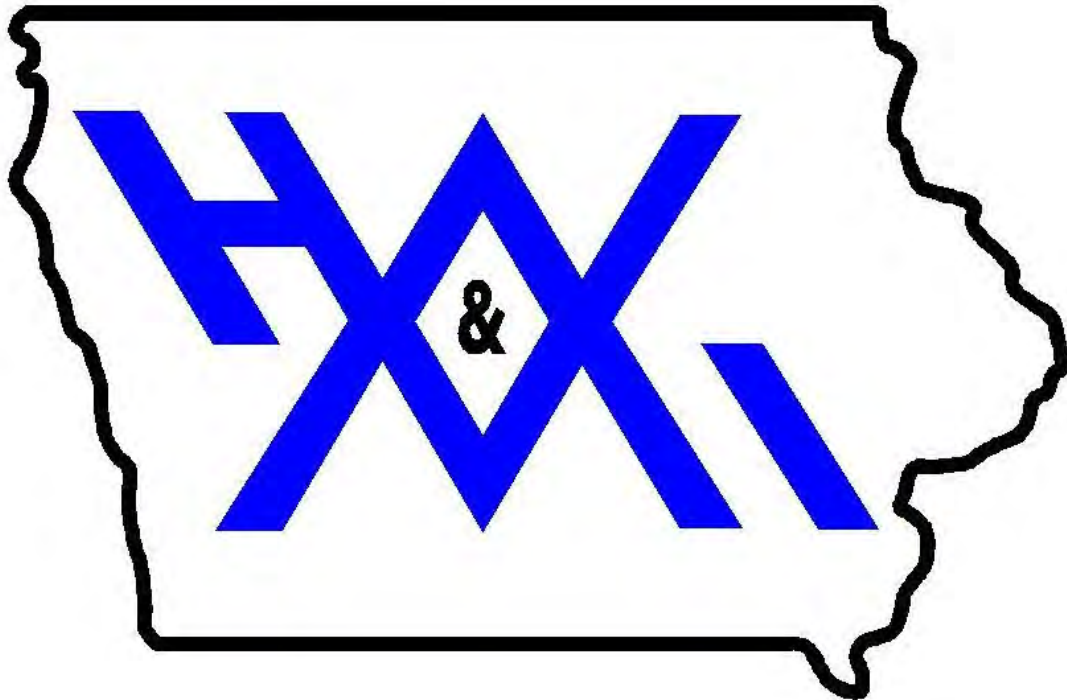

**6224 AVENUE O
FORT MADISON, IA 52627
PHONE: 319-372-7232
FAX: (319) 372-3469
WWW.HUFFMANWELDING.COM**

OCTOBER 2024 EDITION

SERVICES AT HUFFMAN WELDING AND MACHINE, INC.



Machining/Tool & Die

Full-service shop with new state of the art equipment to handle all your precision needs from huge weldments on our large CNC horizontal boring mill to precision ground tool and die parts.



Fabrication & Welding

Certified AWS Welders in Structural, Pipe, Carbon Steel, Stainless, & Aluminum. Our fabricators are not just welders, but they understand how to efficiently and correctly fabricate your projects!



Forming & Sheet Metal

CNC 250 ton x 12' brake with Wila Tooling, 90 ton brake, shears, and more for all your heavy to light precision forming and sheet metal needs.



Laser & Metal Cutting

Amanda Fiber Laser 5'x10'
12'x6' Plasma & Oxyfuel Table
CNC Miter and auto feed Marvel saw



Paintings and Coatings

In-House Wet Paint, Blasting, and Black Oxide. Weekly runs to powdercoat, hot dipped galvanizing and other specialty coaters.

Process Equipment & Controls Integration

Since 1971, we have been building entire factory lines from custom conveyors to full production lines. Contact us to learn about our experience, expert build team and outstanding project management team.
Electrical, Pneumatic, and Hydraulic Controls.

Engineering Services

Software - Autocad, Inventor, SDS/2, Fusion 360, Sigmanest and more
Specialties - Full 3D and 2D machine and part design, reverse engineering with process improvement, strength analysis, and FEA analysis.
ERP/File Management to keep track of all your custom part designs and inventory

Manufacturing

We offer a variety of contract options for manufacturing services.
Part production or complete assembly production.
Part stock room, just in time deliveries, quality inspection and more.
Our ERP system helps keep track of your part demands and part scheduling.

Structural

Certified Welders, Certified Materials, Certified Coatings, Certified SDS/2 Shop Detailers.
We specialize in small structural projects - miscellaneous steel, staircases, mezzanines, etc.
Equipment - Lincoln PythonX Structural Processor, CNC Saws, CNC Pressbrakes, Ironworkers, Punches, Drills, and more.

Equipment Repair & Reverse Engineering

Heavy construction equipment, industrial equipment, OEM replacement parts, and more.
Our expert team has the knowledge to properly repair and fix your broken equipment using repair methods that will last as long or longer than the original equipment.

Installation and Site Support

We can handle the entire installation or help oversee your installation team to make sure your project gets completed and in the end zone!
Our job is not done until you are satisfied!

On The Road Customer Service, Toolroom Supply, and Steel Sales

Our on the road sales team can supply your plant with all their toolroom needs including hardware, drillbits, steel sales, small engine equipment, power tools, and more.
We have a large on-hand inventory of carbon steel, stainless and aluminum in sheet, plate, rounds, flats, angles, channels, tubing, rebar, and more.
Our massive on-site bolt room has grade 5, grade 8, A325, galvanized, stainless, SHCS, & more.
We also stock a large variety of hardware at all 3 farm and home locations. With our Huffman's Farm & Home division we can offer you a huge line card of vendors that we wholesale from www.huffmansfarmandhome.com.



RECENT ADDITIONS AT HUFFMAN'S

2024 Doosan CNC Mill DNM 750/50L – 85.03” x-axis, 30” y-axis, 25.6” z-axis (85x30 table) with 3,968lb capacity, hydraulic 4th axis headstock and tailstock for heavy duty 4th axis milling. Machine specializes in high precision machining of medium to large pieces. 50 taper spindle, 8000RPM, Renishaw toolsetter, Renishaw inspection probe

2024 Doosan CNC Lathe 5100LMB – 35.4” swing over bed, 27.16” over carriage, 25.6” capacity turning. 78.8” maximum turning length, 90.82” between spindle nose and tailstock center, 6.55” bore through chuck, mill-drill capability reduces need for secondary operations, programmable hydraulic tailstock and self-centering steady rest

2023 Amada Ventis 6KW Fiber Laser – 5’x10’ tables – up to 1 1/4” carbon / 1” stainless steel

2023 Mitsubishi Wire EDM MV2400-ST Workpiece Capacity: 41.3” x 32.3” x 16.5”

Davi CNC 4-roll Roller MCA 2020 6’ wide x 7/16” capacity – can roll cylinders, half moons, and cones

2022 Doosan CNC mill 48” x-axis, 24” y-axis, 20.1” z-axis with Renishaw probe

2021 Fermat CNC horizontal boring mill with 4th axis - 157.5"x-axis x 98.4"y-axis x 59.1"z-axis x 31.5" spindle travel, 22 ton table capacity, 165.4” of swing on 4th axis

2021 Lincoln Python X Structural Steel Processor with capabilities to cut up to 50 ton/week

2021 SDS/2 Automated Shop Drawing Software – In-house certified SDS/2 detailer

2021 Accurpress 250 TON x 12’ 7-axis CNC Press Brake

2021 Ercolina TB60-TC CNC Programmable Pipe and Tube Bender

2021 Marvel Precision Saw 20”x25” capacity, 60 deg miter, +/-0.005 shuttle accuracy

2020 Doosan CNC mill with 4th axis

2020 Doosan CNC lathe with LIVE TOOLING and bar feeder

**2018 New Lucas CNC horizontal boring mill 120"x-axis x 98"y-axis x 48"z-axis x 29" spindle travel
332,832 kWh solar field**

All new state of the art Lincoln welders with pulse technology

36,000lb Yale forklift with sideshift for large project handling

Now with over 65,000 sq feet and up to 10 ton overhead crane capacity

Continued growth since 1971





CNC MATERIAL CUTTING

Laser – Plasma – Oxyfuel – Saw – Structural Processor

CNC Laser and Plasma

- 2023 Amada Ventis 6KW Fiber Laser - 5 x 10 tables – up to 1 1/2" carbon / 1" stainless
- 6 x 12 CNC plasma table
- 6 x 12 CNC oxyfuel table
- Subcontracting partners for waterjet

Sawing and Shearing

- 2021 Marvel Precision Saw 20"x25" capacity, 60 deg miter, +/-0.005 shuttle accuracy
- Hot saws, cold saws, special nibblers and material saws, and more
- Sheet metal shear up to 12GA stainless

Structural Steel Processing

- Up to 36" tall material x 60' long
- Beams, Channels, Angles, Square and Rectangular Tubing, Flat Bar
- Processed complete on all 6 sides for quick, accurate processing





PRECISION MACHINING

Milling - Turning - Wire EDM - Precision Grinding

Manufacturing = CNC machining up to 5000 parts

Large capabilities = Turning up to 165.4" diameter - CNC milling up to 157.5" x 98.4" x 60" with full 4th axis capabilities and probing capabilities

Precision capabilities = Precision grinding and machining to 0.0005

State of the art technology = CNC milling & turning, Wire EDM, 3D modeling and CAM programming, and 3D printing

Investing in new equipment yearly! See our equipment list for our full capabilities!

Engineering and value creation = Solutions for manufacturability & process improvement
Material experience = carbon steels, tool steels, castings, stainless and Nitronic 60, aluminum, specialty alloys, plastics (UHMW, Teflon, etc.)

Reverse engineering available = OEM replacement parts shipped nationwide

Part fit and tolerance knowledge to help ensure proper clearance and fit of parts

Repair machining = Journal & housing repair, bore & bush, metalizing

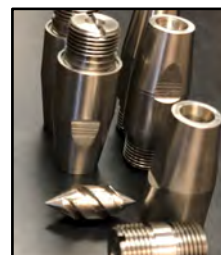

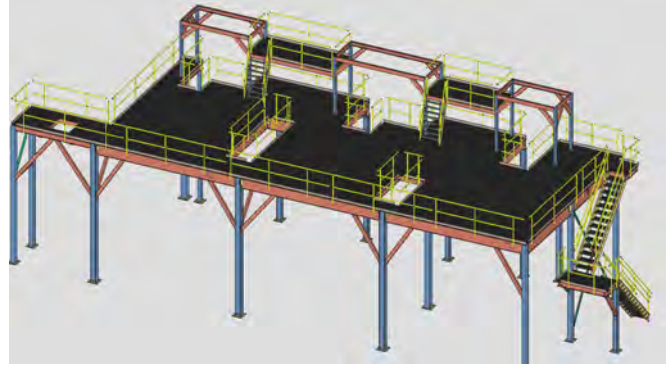
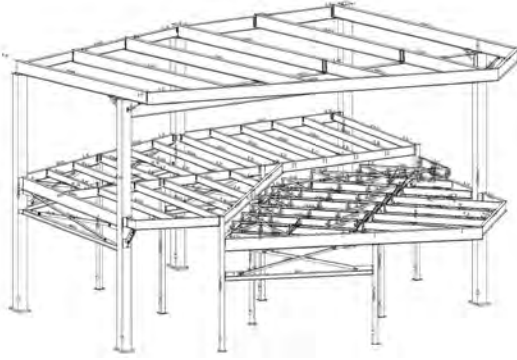

FABRICATION - STRUCTURAL STEEL

Structural Steel & Misc Metals – Metal framed buildings, Staircases, Mezzanines, Platforms, Handrail (made with CNC programmable tube and pipe bender), Embeds, Rebar, Gates, Anchor Bolts

2021 Lincoln PythonX Structural Processor

STRUCTURAL STEEL FABRICATION REINVENTED

- Process all 6 sides of up to 36" tall x 60' long structural members
- Copes, Miters, Holes, Slots, Chamfers, and more



Other equipment includes: Forming up to 250 ton x 12', Ironworkers, Punches, Drills, stud welders, CNC Saws and availability of our full machine shop

Experience with various structural requirements:

- Shop drawings by certified SDS 3D detailer
- ASTM and customer specs on materials, fasteners, galvanizing
- Certified AWS welders, inspection and tagging of all members
- Ercolina TB60-TC CNC Programmable Pipe and Tube Bender for handrail and more





FABRICATION – CUSTOM

TRAINED & CERTIFIED AWS WELDERS

We train, we certify, we manage, we inspect

MULTIPLE PROCESSES AND MATERIAL EXPERIENCE

Aluminum - Stainless - Carbon - Specialty Alloys

GTAW / GMAW / SMAW / Spot and stud welding equipment

Bore welder & boring machine / Onsite capabilities for MIG, Stick and TIG

LARGE FACILITIES

10 ton cranes, jib cranes, & efficient and well thought out work areas

TECHNOLOGY

Utilizing the latest technology in Lincoln inverter and pulse welders

State of the art equipment for material production – 6 axis structural processor,

Davi CNC 4-roll roller, 7-axis 250 ton pressbrake, CNC tube bending and rolling,

drills, ironworkers, full service machine shop and more.

INSPECTIONS

In-house Visual, Dye-Penetrant, and Magnetic Particle Inspection

3rd party inspections available as needed

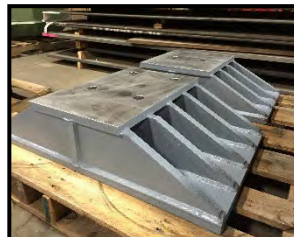
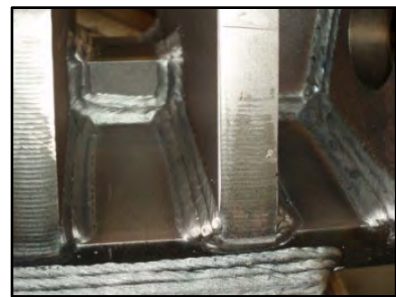

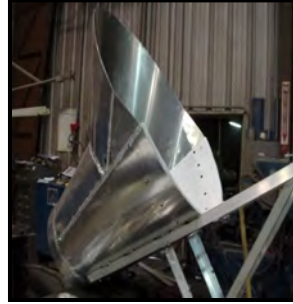
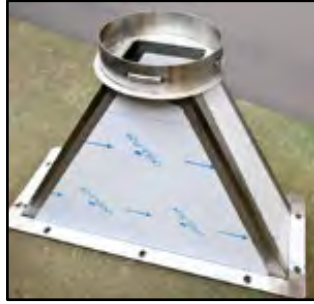

FORMING AND SHEET METAL FABRICATION

MATERIAL CUTTING – 2023 Amada 6000 fiber watt laser - can cut 1 1/2" carbon steel / 1" stainless, CNC Marvel Bandsaw, 6'x12' CNC plasma and oxyfuel cutting

FORMING - Accurpress 250 TON x 12' 7-axis CNC Press Brake

ROLLING - Davi CNC 4-roll Roller MCA 2020 6' wide x 7/16" capacity – can roll cylinders, half moons, and cones

TUBE BENDING - Ercolina TB60-TC CNC Programmable Pipe and Tube Bender

TUBE ROLLING – Cole-Tuve PK-35 Tube/Round/Angle Roller

Spot Welder / Rivnut and other sheet metal fasteners assembly

Our engineers can provide 3D layouts, modeling for ductwork projects, transitions layout and design, and our experienced team can ensure project success!

Production Forming / Custom Ductwork / Transitions / Hoppers / Chutes / Tanks



PAINING, COATINGS, HEAT TREAT AND SURFACE TREATMENTS

Stainless Finishes:

HWMI is an expert in polished stainless with 1000's of projects completed in various stainless finishes.

Passivation - In-house passivation

Pickling – in-house pickling

Polishing - Polishing equipment with specialized finishes

Electropolishing / plating and more

Food grade finishes --- over 40 years building food grade equipment with a thorough understanding of the variety of weld finishes / CIP (clean-in-place) designs and much more

Experienced in standard Ra roughness and other finish callouts - 2B Finish / 4b brushed / 5b satin / 7b reflective / 7b mirror / 9b bead blast / 10b – electropolished

We run the best Walter Surface Technologies equipment ensuring consistent finishes!

In-House Services:

Blasting - variety of media available (experience with SSPC standards and specifications)

Wet Paint (full filtered paint booth) – experience in a variety of specifications and standards and various quality procedures. We have worked with epoxies, polyurethanes, alkyd's and more.

We have quality procedures and can meet mil thickness requirements and more.

We have painted many specialty projects including items such as turbines, piping, equipment and more. Let us look at your painting needs!

Black oxide ebonized coating in-house

Passivation - Variety of stainless finishes and protective coatings with passivation of stainless welds and small jobs in-house

Weld-Up / Spray Metalizing for repair work

Deburring – hand and vibratory deburring machine

Polishing - HWMI has provided various polished finishes on stainless and aluminum with a variety of specialized polishing equipment in-house.

Partnerships:

Powder Coating --- we pickup/deliver from our powder coat supplier weekly on a standard route truck.

Yellow Zinc and Other Coatings

Hot Dipped Galvanizing with expediting next day turnarounds available ASTM A123 (or any ASTM specification)

Heat treating and Stress Relieving- in-house and through a partner with quality documentation and testing reports available if requested

Plasma Coatings – all types of plasma and spray metalizing coatings

Hard Chrome – Hard chrome buildup up to .017" in buildup for long lasting wear components

Heat Treatment - Induction / carburizing / case hardening / annealing (normalization) / nitride coatings / cryogenic treatment / and more

Materials:

We can partner with you in the initial design phase of your project and consult our many highly experienced designers and engineers along with our expert heat treat partners to help determine the best material for the hardness or ductility you are trying to achieve. We are experienced with almost all materials --- 4140 / 4140 PH / 4340HT / Stressproof 1144 / A2 / D2 / Nitronic / Safurex / 316 / 304 / Aluminum 3003 and 6061 / and many more!

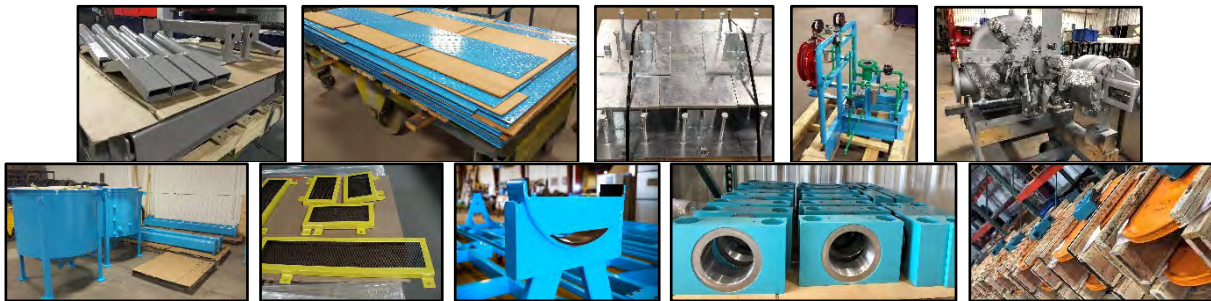

QUALITY CONTROL AND INSPECTION

ISO 9001:2015 COMPLIANT

Full ISO 9001:2015 compliance manual and implementation

QUALITY DESIGN AND REVIEW

3D design with review for fit, function and manufacturability

PE approvals by 3rd party for designs including Finite Element Analysis

THE RIGHT TEAM AND PROCEDURES

Full time quality inspector

The right team with experience inspecting and ensuring compliance with a variety of tolerances and design requirements

Global Shop enterprise resource planning (ERP) software and project management and scheduling, 3D design and CAM Programming, Geometric Modeling for Structural Steel (SDS/2), and more

Certificate of Conformance and MTR's available

SAM approved, CMMC Cyber Security

ISIR, PPAP, PPVP –comply with inspection processes per customer requirements

THE RIGHT EQUIPMENT AND TOOLS

- Renshaw RMP60 probe inspection
- Renishaw OMP60 probe inspection
- Multiple granite inspection tables
- Full range of precision calibrated micrometers and calipers
- Specialty micrometers for threads, internal measurements and more
- Precision calibrated height gages
- Hardness testers, paint mil gages
- Subcontract partners for laser and CMM detailed 3rd party inspections
- Providing 100% customer satisfaction and per spec parts since 1971



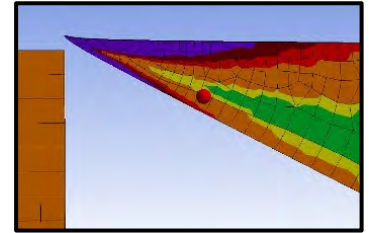
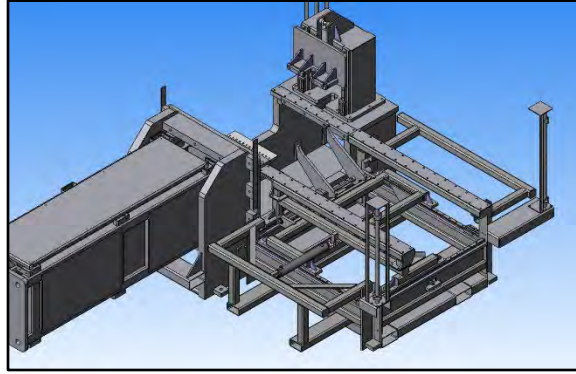
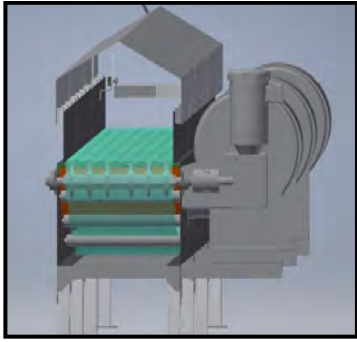

WE WORK HARD TO CREATE VALUE FOR OUR CUSTOMERS BY UNDERSTANDING YOUR PROCESSES AND DEVELOPING INNOVATIVE SOLUTIONS THROUGH DESIGN EXPERIENCE, DESIGN TECHNOLOGY, IN-HOUSE PROCESSES, AND UNDERSTANDING MANUFACTURABILITY

ENGINEERING DESIGN AND PROJECT MANAGEMENT

MECHANICAL AND PROCESS IMPROVEMENT DESIGN

AutoCad 2D & 3D inventor / SDS structural shop drawings with PE approvals and finite element analysis / Global Shop ERP and project management and scheduling

A LARGE TEAM OF DESIGN AND PROJECT MANAGEMENT EXPERTS WITH OVER 300 YEARS OF COMBINED EXPERIENCE

We think outside the box and utilize technology and experience to solve your problems.

OUR PROCESS

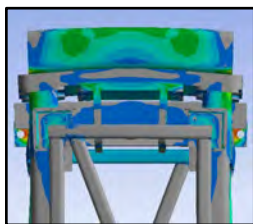

- Understand how parts or components work and the end goals for the parts
- Define and understand quality expectations
- Think outside the box and be innovative
 - Provide suggestions on improved design for function or reducing cost
- Keep you informed in all phases of the design and manufacturing process
- Quality Control – part inspection, final testing
 - We get the ball in the endzone and ensure your complete satisfaction.

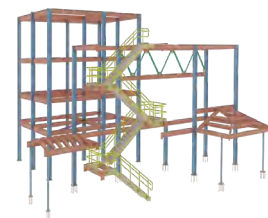



PROCESS EQUIPMENT ASSEMBLY AND PROJECT MANAGEMENT

**WE HAVE MANAGED AND MANUFACTURED FULL FACTORY LINES
WITH EXPEDITED LEADTIMES AND EXCEPTIONAL VALUE**

If you don't think it can be done. Think Again. Then Call us. That's what we do

Experienced Mechanical and Controls Team Members

We Manage Projects From Start to Finish:

- Engineering – New design or completion of any drawings as required / understanding the needs of each project
- Procurement of all raw materials and components (Developing the best vendors since 1971)
- Fabricating all frames and parts / Machining all components
- Coatings – In-house wet paint or black oxide, and outside processes such as yellow zinc, anodizing & hard chrome
- Heat treatments – stress relieving, heat treatment (case hardening, flame and induction hardening, carburizing, etc.)
- Complete mechanical assembly
- All pneumatic and hydraulic systems and plumbing
- Wiring of main controls and components
- In-house hydraulic fittings and hose manufacturing
- PLC programming – subcontracted or we will work with your team to complete programming here for test out
- Runout, Debugging and testing before shipment
- Final skidding, crating, and shipping
- Installation support or full Installation by HWWMI

CUSTOM MATERIAL HANDLING AND PROCESSING EQUIPMENT FOR HEAVY INDUSTRIAL



PROCESS EQUIPMENT REBUILDS

We have a expert team to lead your equipment rebuild project. When we are done it will look and run like new! Whether it's a new build or a refurb, contact us, and see why companies have trusted us to build their equipment since 1971!

We can reverse engineer and modernize or beef up your equipment to improve areas of weakness and give you what you really want! We have made process improvements on customer process ovens, conveyors, choppers, extruders, shears, and much more.



JOURNALS, HOUSINGS, & PART REPAIR

Multiple repair processes in-house for quick turn-arounds!

In-house Spray Metalizing and weld buildup of worn components

In-house Portable Bore Welder – Weld & Bore from 1.9" up to 10" Diameter x 36" outside faces

Partners in other coatings such as hard chrome buildup up to .017"

COATINGS AVAILABLE TO MAKE YOUR REBUILT SHAFTS, JOURNALS, HOUSINGS, AND PARTS LAST LONGER



CONSTRUCTION EQUIPMENT REPAIR

Wrecked equipment rebuilds – boom arms, buckets, sheep feet, scraper repairs, asphalt reclaimer and equipment repairs, pile driver equipment repairs, misc damaged or wrecked equipment, and much more.



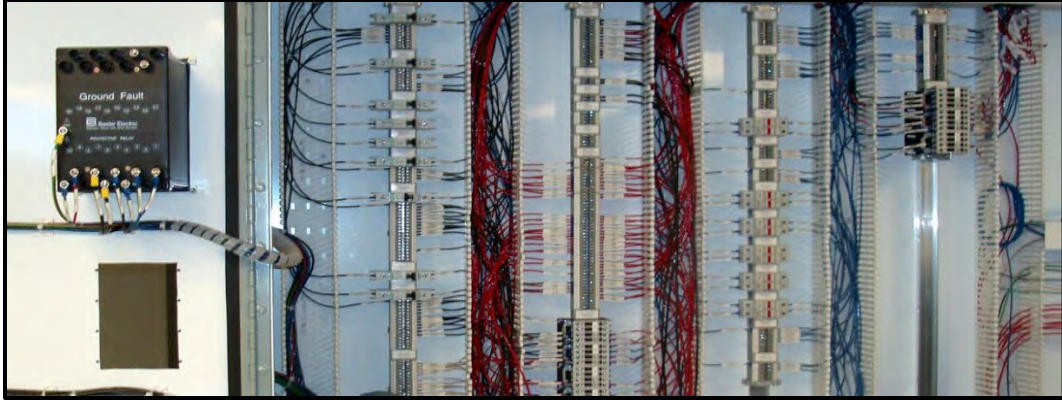

ELECTRICAL, PNEUMATIC, AND HYDRAULIC CONTROLS ASSEMBLY

In-house licensed electrician and mechanical assembly experts

Every large production line and machine we manufacture has controls. We can work with you to do initial electrical runs back to control panels or armorblocks, do complete panels on simple systems or partner with a control panel shop or your in-house team on complex panel builds and PLC programming. We have experience in pneumatic systems and cabinets as well as complete hydraulic design/builds.

In-house hydraulic fittings and hose making

Runouts and machine acceptance testing can be completed in-house with use of our motor starters, VFD controllers, pumps and other various test out equipment.

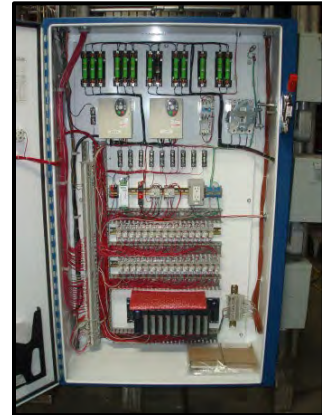
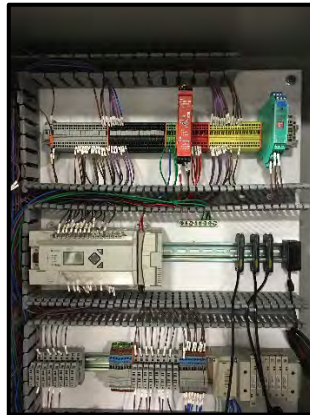



EQUIPMENT INSTALLATION & ON-SITE WORK

Our road crew can travel to work on bridges, install projects, and help with turn-arounds.

Our craftsmen know how to handle precision installations and work safely. The team will work to effectively communicate, think outside the box, and develop solutions to keep costs down while ensuring quality.

Onsite welding and repair





WHY US?

Value – We strive to provide value in every project – design review, cost, quality and schedule

Convenience - From concept to completion - one-stop turnkey shop

Solutions – We do what others can't and create innovative solutions to meet schedules, budgets and project goals

Quality – Exceeding your expectation is always a priority at Huffmans

Safety - Strict safety program and superior record with regular OSHA consultation visits

Confidentiality – We hold high confidentiality clearances with some of the largest companies and work hard to ensure your proprietary information remains yours!

Large Capacity – Large manufacturing spaces, In-house equipment capacity, and project management experience for big projects

Dedication - Focused project teams – on time, on budget. PERIOD

Satisfaction – Continuous improvement to make sure you are always happy

Community, Customer, Family, and Employee Focused



FULL SERVICE SHOP

American craftsmanship, producing guaranteed quality.

From prototypes to full production, HWMI has the experience and capacity to provide excellent leadtimes and pricing.



RELIABLE AND EXPERIENCED

10 Project Managers with over 300 years experience. Over 110 employees total each providing excellent value and expertise.



THANK YOU

Our dedicated team promises to provide value to you in all we do. We will provide you with what you need, when you need it, and at the most competitive price. We Thank You for the Opportunity!

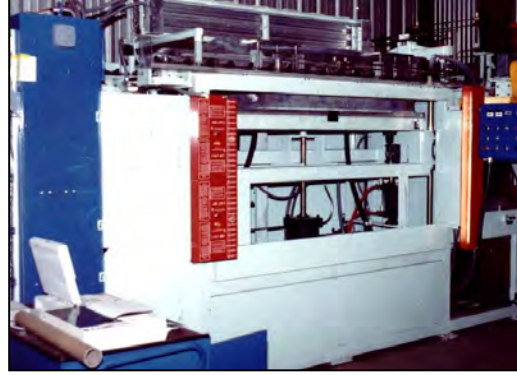

REFERENCES / CONFIDENTIALITY

We have a long list of references we can supply at your request. However, many of our customers ask for confidentiality and we have the strictest policies and agreements in places. Your confidential projects are secure at HWMI. We will always seek your approval before using pictures or prior to working with subcontractors, etc. We hold the highest confidentiality rating with some of the largest industries in America and the government allowing us to build some of the most proprietary equipment in our secure facility.

Huffman's has grown since 1971 by word of mouth due to the quality of work and level of service we provide. Our customers continue to come back to us time and time again.

Let us show you why Huffman's is a trusted source for all your projects.

Our key customers include those in the rubber, ammunition, steel production, foundries, chemical production, fertilizer production, commercial construction, agricultural equipment manufacturers, food grade equipment, automotive manufacturers, plastic and polyurethane injection and rotational molding, power generation, locomotive bridges, and the United States Government.

Duns Number: 055804850 Cage Code: 3FQD1 TPIN #: 45993923
GOVERNMENT SAM AND CYBERSECURITY APPROVED
Small Business / Hubzone Business





Full Paint Booth



Large Capacity Turning and Milling



Forming up to 250 tons x 12'



CNC Technology --- HWMI is efficiently manufacturing for tomorrow

OUR EQUIPMENT AND FACILITIES



Boring up to 120" x 98" x 29" with Cat50 Spindle



Fully automated 6 axis structural processor



Large Inventory of Fasteners and Parts



Large Saw Cutting and Material Handling



Large Steel Supply Warehouses



Full Service Sales, Supply, and Trucking Services



WIRE EDM



Continuously Upgrading and Improving Our Processes and Systems

6224 Avenue O
Fort Madison, IA 52627

HUFFMAN WELDING & MACHINE, INC.
WWW.HUFFMANWELDING.COM
319-372-7232



Team Capabilities

- Founded in 1971 with over 110 employees companywide and 55 at Huffman Welding & Machine, Inc. division with many craftsmen having over 60 years and 100,000+ hours of experience in machining, fabrication, machine building, equipment repair, specialty repair, quality inspection, and material cutting and supply.

Fabrication and Welding

- Lincoln Structural Steel 6 axis processor as noted below under "material cutting"
- MIG, TIG, Stick, Spot - Carbon, Stainless, Aluminum, Specialty Alloys
- On-Site MIG, TIG, and Stick for Stainless and Carbon
- Onsite MIG for Aluminum
- 15+ Welding Power Sources. - We run new Lincoln electric welders with pulse-on-pulse and power mode technology and inverter technology. 500+ amp units and more
- Automatic weld positioners and rollers and other fixturing
- Portable pipe and plate chamfer milling machine
- Bore welder and boring machine 1.9" up to 10" bores
- Nelson stud welder up to 1/2" dia
- In-house Visual, Dye-Penetrant, and Magnetic Particle Inspection

Plate and Tube – Forming / Rolling / Bending

FORMING - 2020 Accurpress - 7-axis CNC, 250 TON x 12', 12" stroke
--- Utilizing the world's most accurate pressbrake and tooling technology
--- Precision WILA new standard tooling including goosenecks and roll-a-vee
--- Box Brake for light GA box forming
ROLLING - Davi CNC 4-roll Roller MCA 2020 6' wide x 7/16" capacity – can roll cylinders, half moons, and cones
TUBE BENDING - Ercolina TB60-TC CNC Programmable Pipe and Tube Bender
TUBE ROLLING – Cole-Tuve PK-35 Tube/Round/Angle Roller
Fastening - Spot Welder / Rivnut and other sheet metal fasteners assembly

Material Cutting - CNC Laser, Plasma, Oxyfuel, Structural Processor

- Lincoln PythonX Structural processor – 6 sided processing 36" tall x 60' long for beams, channels, angles, square and rectangular tubing for all copes, miters, holes, slots, chamfers, etc.
- Amada 6000W Fiber Laser with 5x10 table - up to 1 1/2" carbon and 1" stainless thickness capacity
- CNC Plasma and Oxyfuel Table with 6x12 table up to 12" thick capacity
- Subcontracting partners for waterjet
- Multiple handheld high-powered plasma and acetylene torches and air arc machines
- Pexto Shear - 10' x 10 ga - 1/4" x 3'

Saw Cutting

- Marvel Precision Vertical with Miter Cut Bandsaw - VT5063SW fully automatic 20x25" capacity, 20" rounds, At 45 deg - 20x17 or 17 on rounds, At 60deg 20x11.25" or 11.25 rounds. 1 1/2" blade Flood and mist coolant Position accuracy of +/-0.005 Stock cut lengths for machining of no more than .040" over machined lengths on large parts
- Automatic-band saws, hot saws, cold saws, special nibblers and material saws, and more.

Painting, Sandblasting and Special Coatings

- Large exhausted wet paint booth
- Various size sandblasters (large capacity for big vehicles/equipment)
- Cleanroom for clean part drying
- In-house spray metalizing
- In-house black oxide coating system
- Subcontracting partners for powder coating, galvanizing, heat treat, plasma coatings, and hard chrome buildup up to .017" and more

In-House Shaft and Journal Repair (Welding & Spray Metalizing)

- Weldup of any shaft end or any diameter with automated weld positioners
- Spray metalizing with buildup capabilities between 3/16"-1/4"
- Bore Welder 1.9" up to 10" bores up to 10" deep roughly 36" long outside to outside on faces
- H-frame presses up to 150 ton x 4' x 8 1/2' for removal/installation of bushings, bearings, gears and more

Material Handling

- Cranes spanning 275' long with 18' hook height / 30 TON capacity
- Network of overhead cranes and jib cranes throughout facility for efficient movement of material
- 12+ forklifts that move material up to 36,000 lbs

Wire EDM

- 2023 Mitsubishi Wire EDM MV2400-ST Workpiece Capacity: 41.3" x 32.3" x 16.5"

Milling - CNC large horizontal capacity up to 157.5" x 98.4" x 31.5" with 22 ton table capacity and 3 mills with 4th axis including largest new CNC boring mill

- CNC Ferret WFT 13 New 2021 horizontal boring mill with full 4th axis rotary table. 157.5" on x-axis, 98.4" y-axis, 59.1" Z-axis, 31.5 w-axis, Swing of 165.4" diameter on 4th axis with max cutting diameter of 115.2", 22 ton table with size 70.8"x86.6", 5.1" cat 50 spindle with 31.5" of travel. 40 tool changer and Fanuc 31iB controller and Renishaw RMP60 probe, and 90 degree rotatable head
- CNC Lucas purchased new 2018 40T1210 horizontal boring mill with 20 ton table capacity and range of 120" x-axis x 98" y-axis, 5.1" Cat 50 spindle with 29" of travel. 32 tool changer and Fanuc Oi-MF controller. 90 degree rotatable head
- 2024 Doosan CNC Mill DNM 750/50L – 85.03" x-axis, 30" y-axis, 25.6" z-axis (85x30 table) with 3,968lb capacity, hydraulic 4th axis headstock and tailstock for heavy duty 4th axis milling. Machine specializes in high precision machining of medium to large pieces. 50 taper spindle, 8000RPM, Renishaw toolsetter, Renishaw inspection probe
- Doosan (2) – 1 each 2022 / 1 each 2020 CNC vertical mill – 41.3" x-axis x 22.4" y-axis, 20.1" z-axis and 4th axis milling with Renishaw OMP60 probe
- 2ea purchased 2017 Acer CNC toolroom mills including 4th axis CNC capabilities
- Multiple traditional horizontal and vertical mills up to - 4" spindle, 84" cross travel, 74" on y-axis, 60" vertical with a 4" x 36" spindle

Turning – CNC with live tooling for milling and bar feeders / Large Capacity Lathes up to 60"

- 2024 Doosan CNC Lathe 5100LMB – 35.4" swing over bed, 27.16" over carriage, 25.6" capacity turning. 78.8" maximum turning length, 90.82" between spindle nose and tailstock center, 6.55" bore through chuck, mill-drill capability reduces need for secondary operations, programmable hydraulic tailstock and self-centering steady rest
- Doosan purchased new 2020 CNC lathe with live milling tooling - GT3100M with 28.3" over bed, 23.2" over saddle and up to 49" between centers, turret with hydraulic chuck and bar feeder up to 4" dia and live tooling for milling, 2800RPM Spindle, 47HP
- Milltronics CNC lathe with 18" chuck x 24" of travel x 48" between centers
- Monarch lathe 60" dia. x 108" length (50" over carriage)
- LeBlond lathe - 48" x 216" length
- Using our heavy duty steady rests and rollers we can machined shafts over 35 feet long
- 8+ other lathes for specialty jobs

Precision Grinding

- Blanchard Grinding up to 36"
- Cylindrical Grinding 14" x 4"
- Surface Grinding 10" x 2"
- Sunnen Hone 3/32" – 2 1/2" diameter x 8" stroke

HWMI Heat Treat

- Oven Dimensions: Inside 8" Tall x 11 1/4" Wide x 16" Long
- Subcontracting partners for larger items that need heat treat or stress relieving, etc.

Quality and Inspection – ISO 9001:2015 Compliant

- Fulltime quality inspector
- Renishaw OMP60 probe and Renishaw RMP60 probe
- Climate controlled inspection room
- Multiple granite inspection tables
- Full range of precision calibrated micrometers and calipers
- Specialty micrometers for threads, internal measurements
- Precision height gage
- Hardness testers, paint Mil gage
- Subcontract partners for laser and CMM detailed 3rd party inspections
- Fabrication - In-house Visual, Dye-Penetrant, and Magnetic Particle Inspection
- Providing 100% customer satisfaction and quality approved parts since 1971

Floor Space

- Over 65,000 Sq Feet of building. assembly/fabrication capabilities for assemblies over 275' long. Contact us for all your large fabrications and projects.

Trucking and Delivery

- Full fleet of delivery trucks including box trucks and semi flatbeds

Material Supply and Inventory

- We have much of the material needed for jobs on-hand and available the day of the job.
- Industrial supply inventory at HWMI/HF&H is one of the area's largest for hardware of all grades and types, metal inventory of carbon, stainless, and aluminum, pipe and pipe fittings, hydraulic fittings and custom hose, & more
- 3 Farm and Home retail locations (see www.huffmansfarmandhome.com)

Huffman Family Management Team



BOB HUFFMAN
PRESIDENT



JASON HUFFMAN
VICE PRESIDENT

THANK YOU FOR TRUSTING US SINCE 1971
WE WORK TO PROVIDE THE BEST SERVICE
AND INNOVATIVE SOLUTIONS TO YOUR PROBLEMS

Project Management and Engineering Team



Jesse Gerst



Jeff Fasching



Steve Norton



Lonnie Lucas



Mateo Alvarez



Craig Metternich



Jeff Morgan

Outside Sales and Customer Service Team



Chad Demoss
Outside Sales / Special Projects
Prior Maintenance Specialist
319-470-5373

cdemoss@huffmanwelding.com



Casey King
Outside Sales
Toolroom Stock and Supply
319-470-1207

cking@huffmanwelding.com



Scott Swanson
Inside Sales Tools and Metal
Metal / Hardware / Tools
319-372-7232

sswanson@huffmanwelding.com